

## Model # 5102

### INSTRUCTIONS

1. First make sure that the supply lines have 3/4" connection that match the inlet connections in the back of the tub filler faucet. If connections do not match an adaptor may have to be obtained from a plumbing store. Cheviot Products suggests using only Cheviot Products' supply line for use with their faucets to avoid any problems.

2. First install the desired supply lines into the floor and connect the plumbing. Next, install the tub filler faucet to the 3/4" connections at the top of the supply lines. Make sure the washer is inserted.

3. Next double check that the water supply lines have hot going to hot side & cold to the cold side. If using 1"OD Cheviot Products supply lines connect the hex nuts at the back faucet to the threaded connections on the top of the supply lines.

4. Install the hand shower cradle on to the top of the faucet body. Place the rubber washer in the hex nut at the base of the cradle and tighten until sealed and secure.

5. To install the shower hose place the 1/2" rubber washers in the cone nuts at both ends of the shower hose. Install one end to the side port on the cradle stand and one end to the bottom of the hand shower. Hand tighten.

6. Once installed, remove aerator and hand shower to flush faucet and water lines. This will remove any debris that may be trapped. Then attach shower head and aerator.

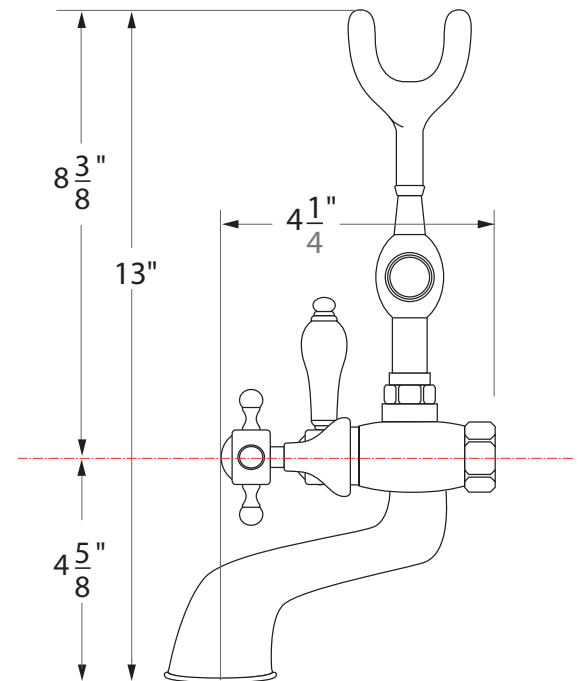
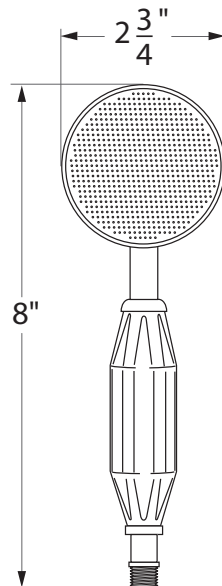
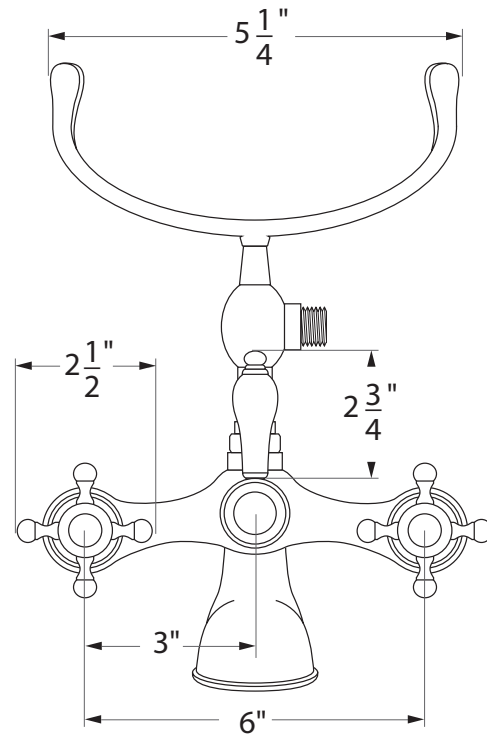

### CARE AND MAINTENANCE

Minimum Maintenance is required to maintain product finish. With proper maintenance your CHEVIOT Faucet will continually look like new. Special care should be taken when cleaning your faucet and the following suggestions should help extend your faucet life.

- Cleaning should be done regularly using a soft cotton cloth and warm water, then towel dry.
- Do not use cleaners that contain abrasives or harsh chemicals; Care should be taken in selecting cleaning supplies. Many cleaners contain detergents, ammonia, or other corrosive solvents that could damage your faucet finish.
- occasionally clean with a non-abrasive wax polish.

# Cheviot

PRODUCTS INC

## Model # 3965

### INSTRUCTIONS

1. Drill two holes 1-1/8" as per your determined measurements.
2. Slide escutcheons up on bottom of each riser tube and install one 3/4" brass flange nut on each riser. Measure from bottom of valve to make sure that the nuts are threaded at same distance.
3. Lower the riser tubes through floor (make sure you have valve handles on the correct sides). Install other 3/4" brass flange nut underneath (leave loose and attach faucet). Then tighten flange nuts, securing riser tubes to floor.
- 4a. If you are using plastic water lines a 3/4" FIP x barb adapter will attach directly to the 3/4" running thread on riser tube.
- 4b. If you are using copper pipe – you will have to use the 3/4" & 1/2" brass reducers and 3/4" fiber washers (make sure you soak the washer in water before using). Put washer between riser tube and reducer and tighten using Allen wrench. Attach to your copper line.
5. Pressure test riser tubes before closing access plate.

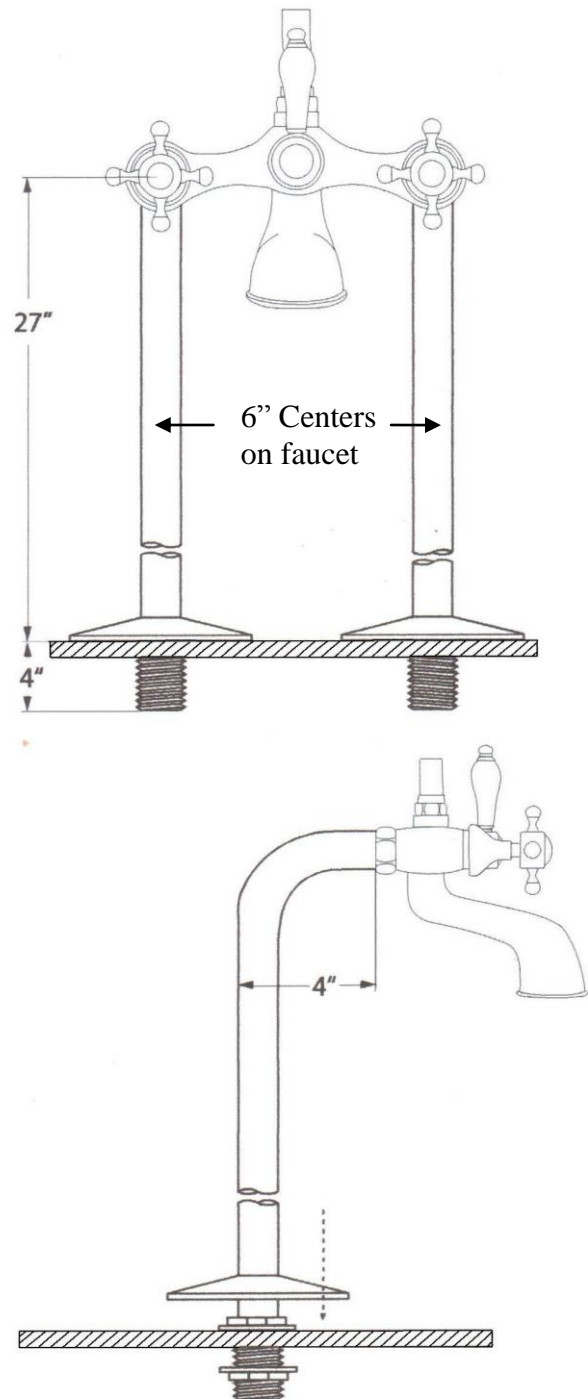

#### NOTE

Before drilling holes in floor, determine the width of the faucet supply line nuts that you want to attach the riser tubes to (these will be for how far apart you will be drilling holes). Now determine where your tub lip will be to make sure faucet spout is at least 1" inside of tub lip.

#### CARE AND MAINTENANCE

Minimum Maintenance is required to maintain product finish. With proper maintenance your CHEVIOT Faucet will continually look like new. Special care should be taken when cleaning your faucet and the following suggestions should help extend your faucet life.

- a) Cleaning should be done regularly using a soft cotton cloth and warm water, then towel dry.
- b) Do not use cleaners that contain abrasives or harsh chemicals; Care should be taken in selecting cleaning supplies. Many cleaners contain detergents, ammonia, or other corrosive solvents that could damage your faucet finish.
- c) occasionally clean with a non-abrasive wax polish.

Tel : (800)-444-5969

www.cheviotproducts.com