

7512

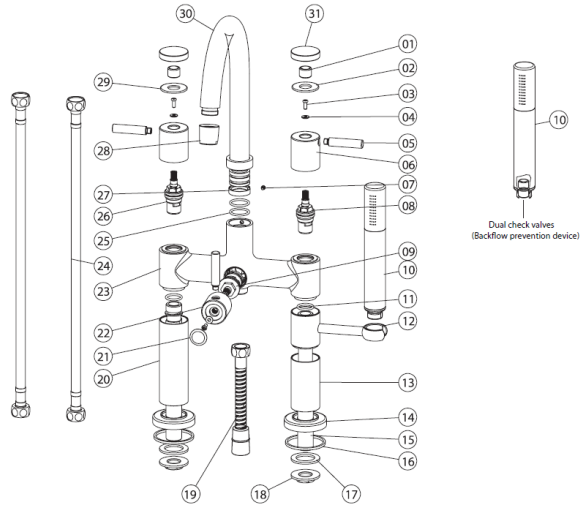

Component Parts List

#	PART NAME	QTY	#	PART NAME	QTY
01	BOLT	2	21	INDEX BUTTON	1
02	INDEX RING(COLD)	1	22	HANDLE	1
03	SCREW	3	23	HOUSING	1
04	O-RING	3	24	HOSE	2
05	HANDLE LEVER	3	25	O-RING	2
06	HANDLE	2	26	CARTRIDGE	1
07	SCREW	1	27	SNAP RING	1
08	CARTRIDGE	1	28	AERATOR COVER	1
09	DIVERTER	1	29	INDEX RING(HOT)	1
10	HAND SHOWER	1	30	SPOUT	1
11	O-RING	2	31	END CAP	2
12	HAND SHOWER HOLDER	1			
13	SLEEVE EXTENSION	1			
14	DECORATIVE RING	2			
15	CONNECTOR	2			
16	O-RING	2			
17	WASHER	2			
18	LOCK NUT	2			
19	HOSE	1			
20	SLEEVE EXTENSION	1			



Tel : (800) 444-5969

www.cheviotproducts.com



Installation Instructions

MODEL #7512: CONTEMPORARY RIM MOUNT TUB FILLER

Before Your Installation

- Read all instructions carefully.
- Turn off main water supply before removing old faucet and fixtures.
- Clean surface before installing new faucet.
- Insert a cloth or stopper into drain to prevent small parts from getting lost.

Tips for Successful Installations

- Use joint compound or Teflon® tape on all threaded connections to prevent leaks.
- Use a soft cloth to protect the faucets finish when using a wrench, pliers or other tools that could scratch the faucet.
- Tighten all hose connections by hand. Do not over tighten.
- Before turning main water supply back on, open several faucets around the house to prevent pressure from building up.
- Remove aerator from faucet before turning on water. Flush drain for several minutes before replacing aerator. DO NOT use joint compound or Teflon® tape to reconnect aerator.

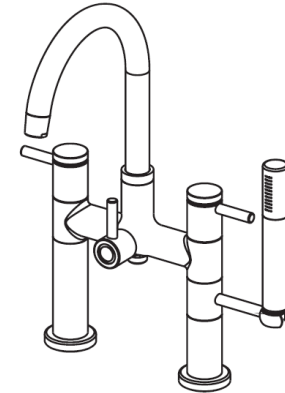

Specification Sheet

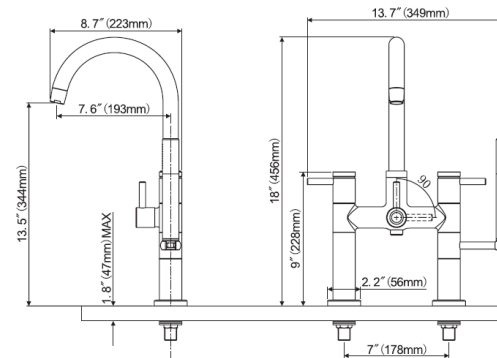



Adjustable Wrench



Pipe Tape



Groove joint plier



Allen Wrench
5/32" (2.98 mm)
3/16" (4.76 mm)



Plumber's putty



Phillips screwdriver

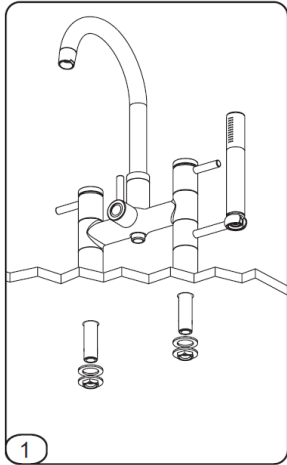

1 Remove mounting hardware from stem of faucet. Insert gasket under rim of faucet and is firmly seated into groove. From underneath sink, place rubber gasket and metal washer on stem. Then use a wrench to tighten as needed.

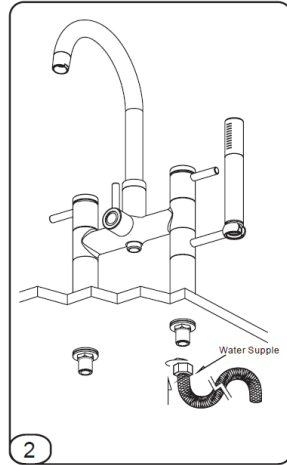

2 Connect main water supply lines to bottom openings of stems.

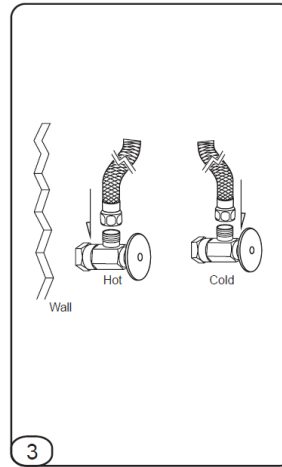

3 Connect other end of main water supply lines to wall water supply valves.

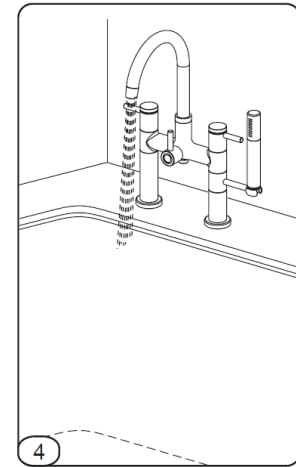

4 Connect shower body with shower hose.